



# **CATÁLOGO DE CONDUCTOS DE AIRE DE CHAPA METÁLICA**

**SECCIÓN RECTANGULAR  
SECCIÓN CIRCULAR Y OVAL  
UNIONES DE ANCLAJE**

**CONDUCTOS DE AIRE DE CHAPA METÁLICA - SECCIÓN RECTANGULAR**

**Conducto recto**

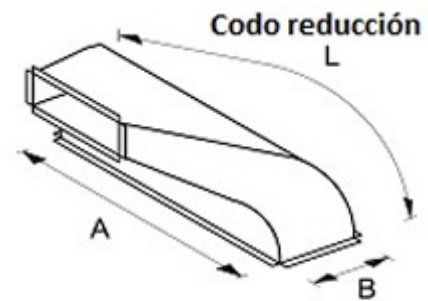
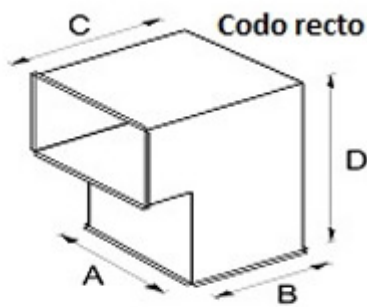
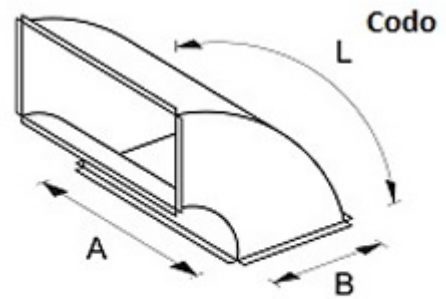
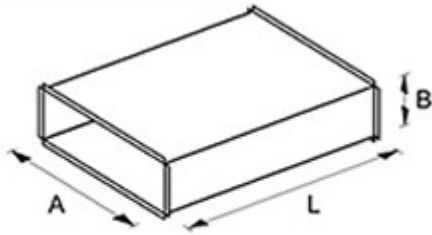

**Reducción**

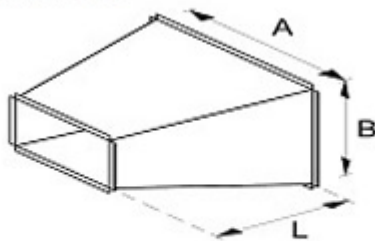

**Transformación Concéntrica**

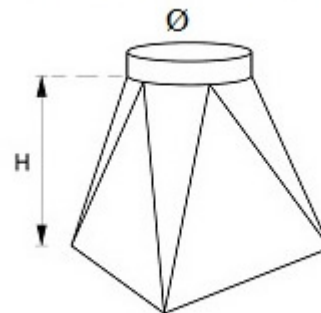

**Transformación excéntrica**

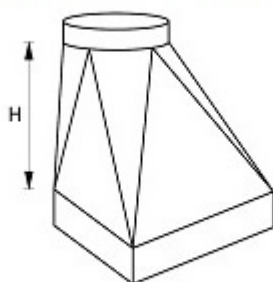

**Transformación con desvío**

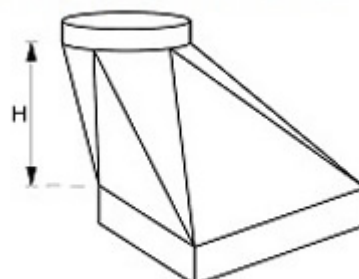

Zapato

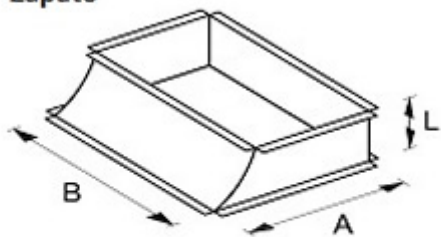

Cuello

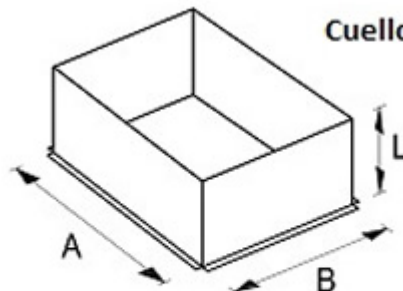

Cuello telescópico

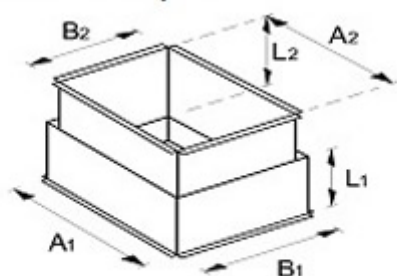

Vierte aguas

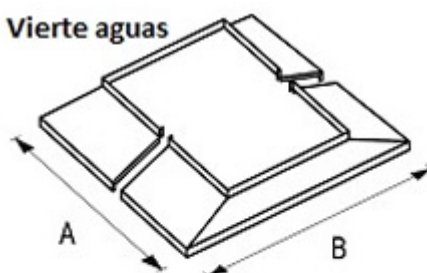

Desvío

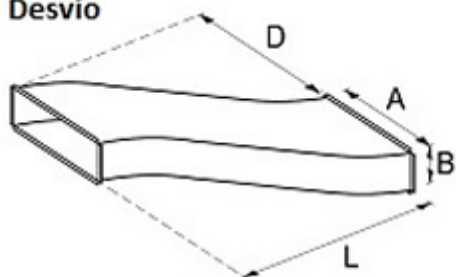

Pantalón

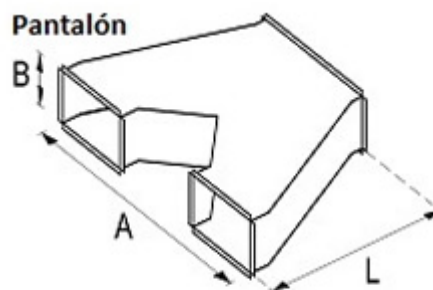

Tapa

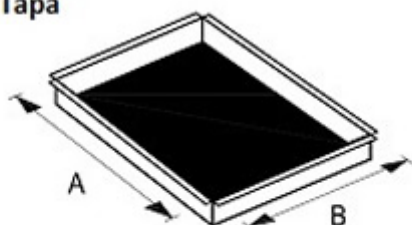

Deflector

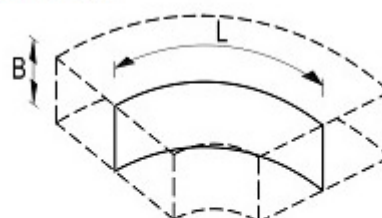

**Bifurcación**

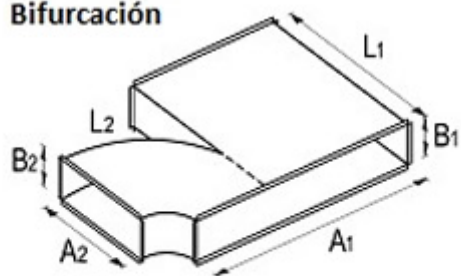

**Bifurcación Doble**

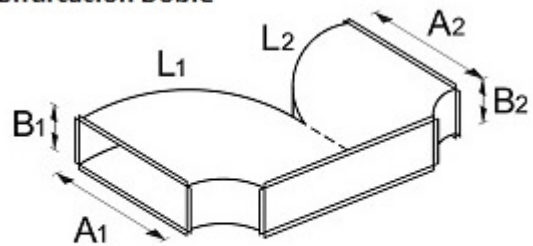

**Bifurcación triple**

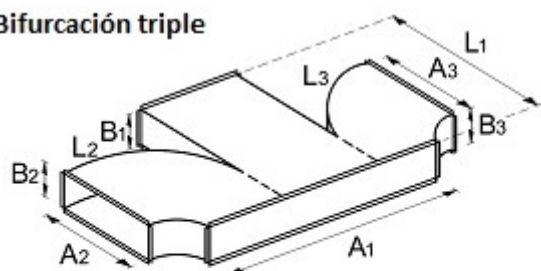

**CONDUCTOS DE AIRE DE CHAPA METÁLICA - SECCIÓN CIRCULAR Y OVAL**

TUBO RECTO

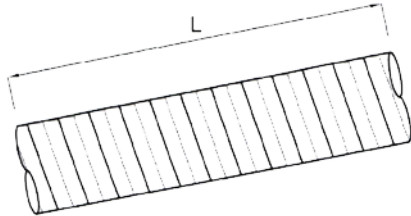

TE SIMPLE

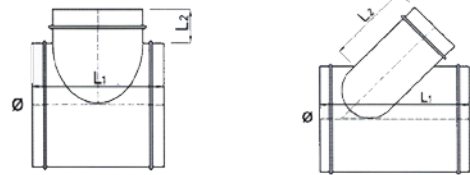

TE CÓNICA

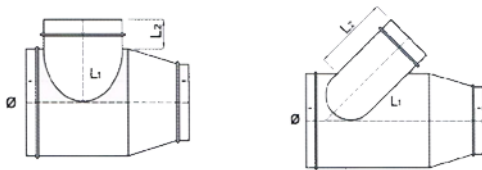

CRUZ SIMPLE

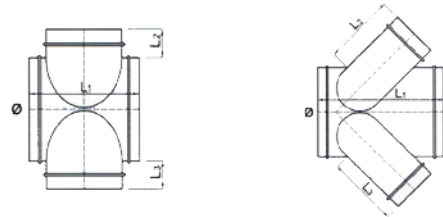

CRUZ CÓNICA

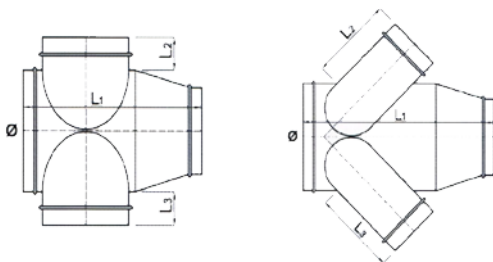

INJERTO RECTANGULAR SOBRE CIRCULAR

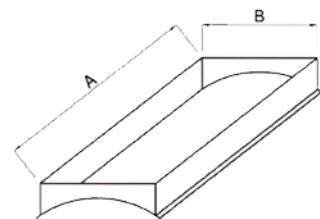

CODO

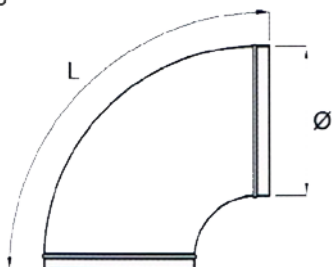

REDUCCIÓN

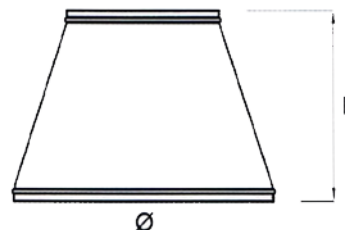

TE DOBLE CÓNICA

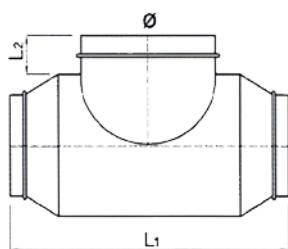

DERIVACIÓN CÓNICA

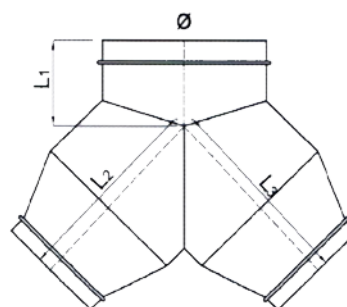

TRANSFORMACIÓN

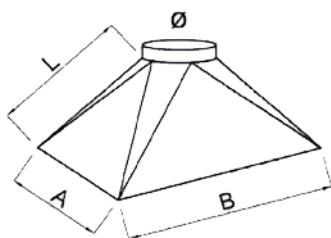

PLENUM

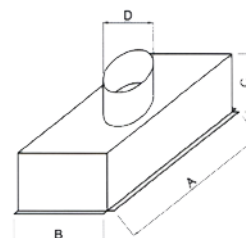

DESVÍO CIRCULAR

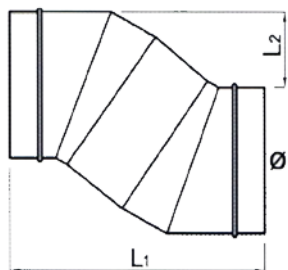

INJERTO PLANO

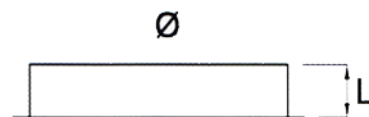

INJERTO CIRCULAR

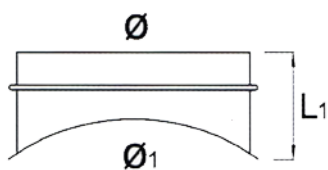

TAPA

